

How the Internet Works

Internet architecture and core protocols

By Mallory Knodel and CATNIP

@malloryknodel
catnip.article19.org

Key inquiries

- How do networks work?
- Who develops internet protocol standards?
- How does internet architecture relate to internet governance?

NETWORK TYPES

CENTRALIZED NETWORK



A network is centralized when many clients connect to a single server. Centralized services or local networks, like game servers, are shaped look like a star with a central point.

DECENTRALIZED NETWORK



We call a network decentralized when many clients connect to many servers that connect to each other. The overall infrastructure of today's Internet looks like this.

DISTRIBUTED NETWORK



Sometimes, clients can also be servers. On a distributed network all nodes are non-hierarchical-ly connected to each other. A fully distributed network, where all nodes speak directly to one another without central nodes, was once the utopia of the internet. The reality is that we are seeing increasing centralisation of major internet services by a few dominant companies.

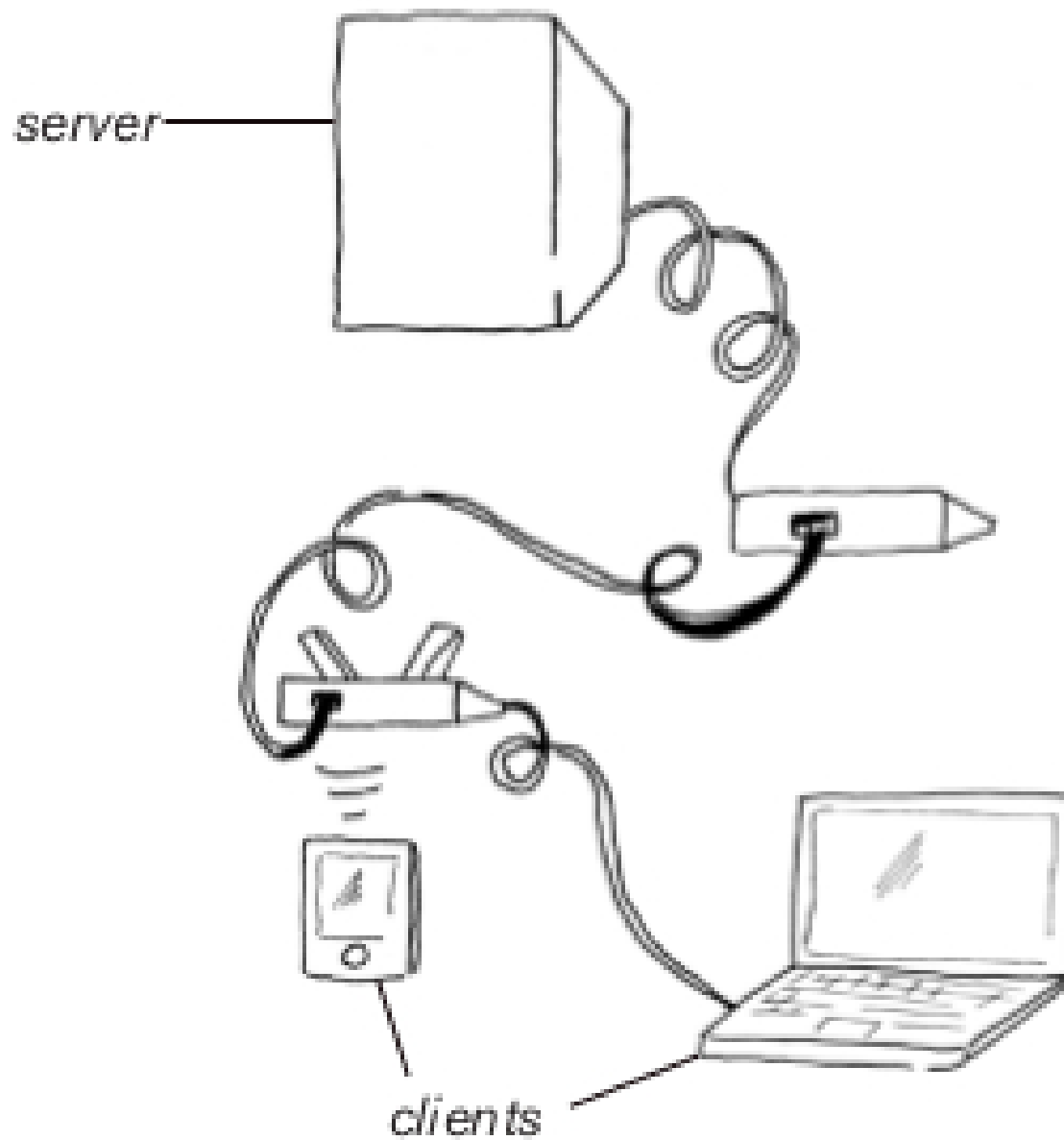

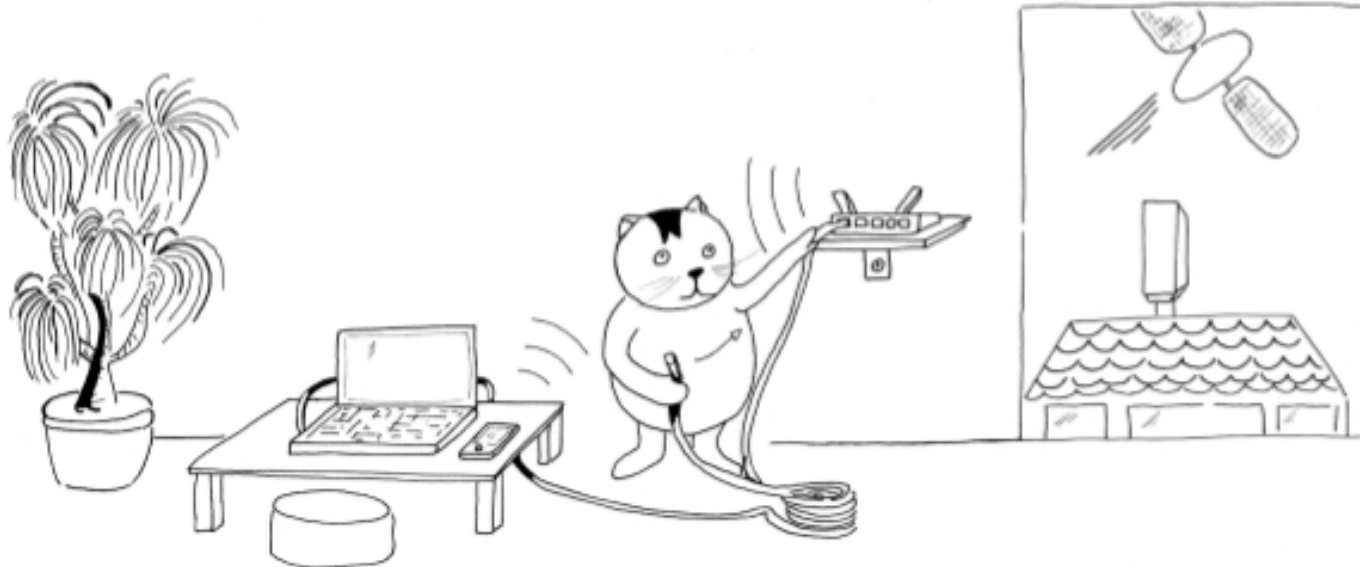

When you connect your computer or mobile device to the internet,

you probably use an ethernet cable or WiFi to connect to your home router.

Or you connect to the Internet via your phone's mobile network, or a satellite network.

TALKING TO THE ROUTER

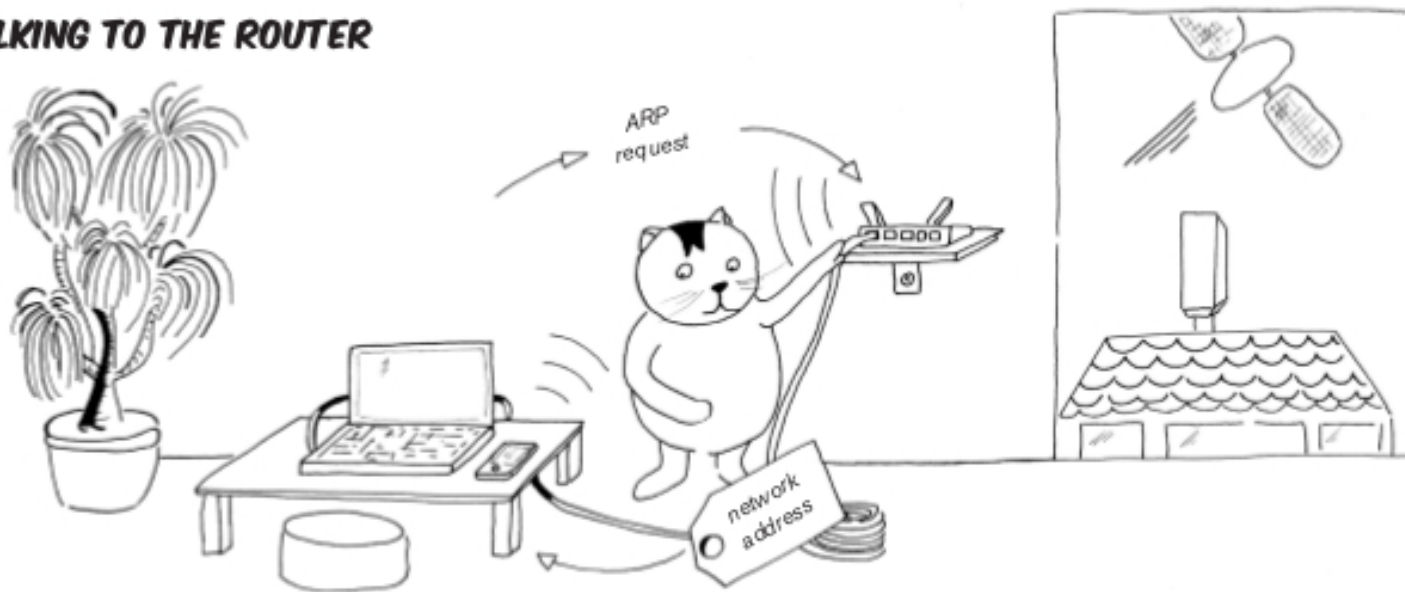

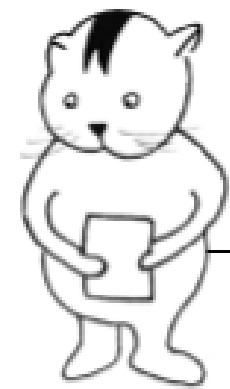

application



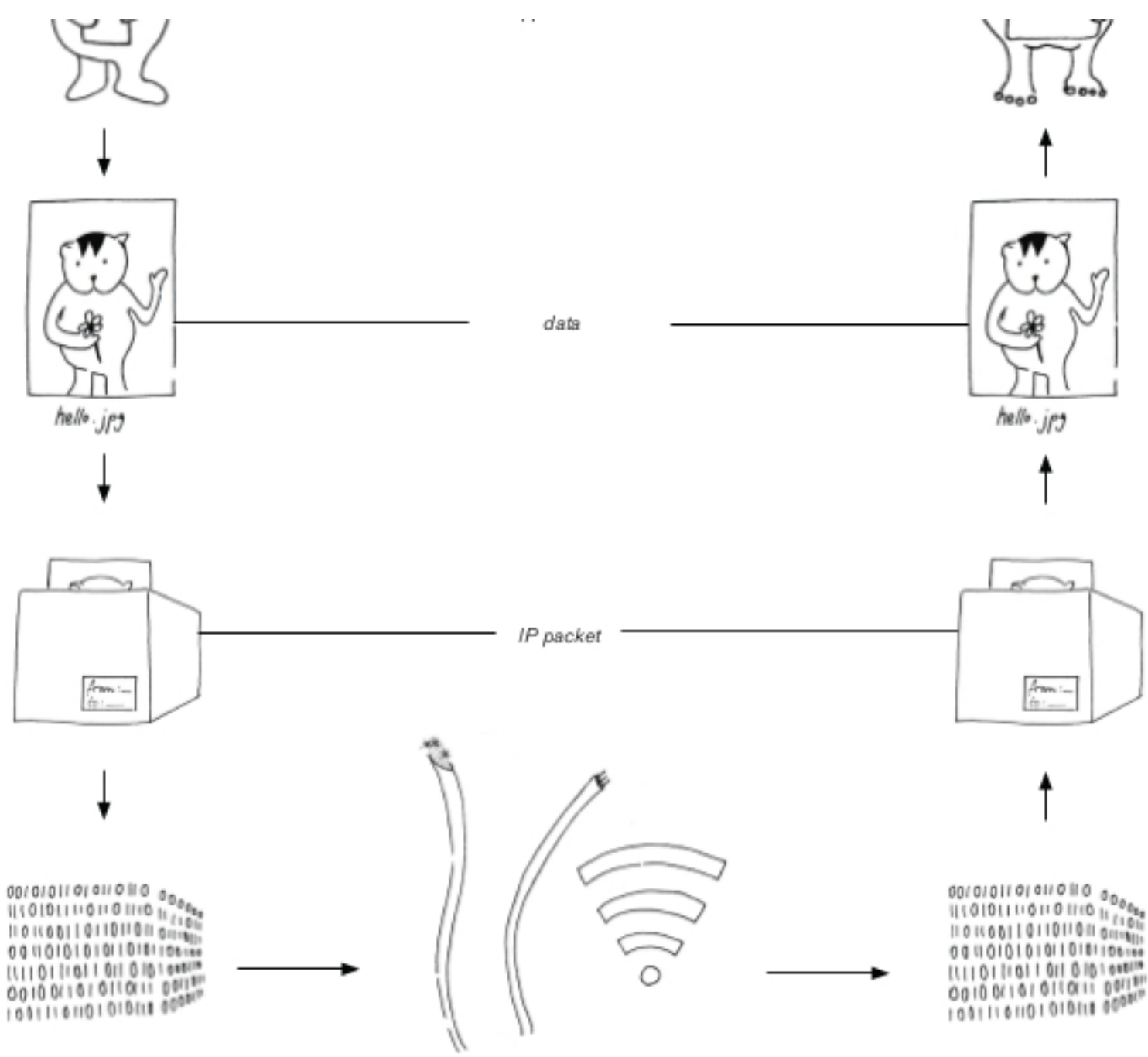

stored as a sequence of one of two states.

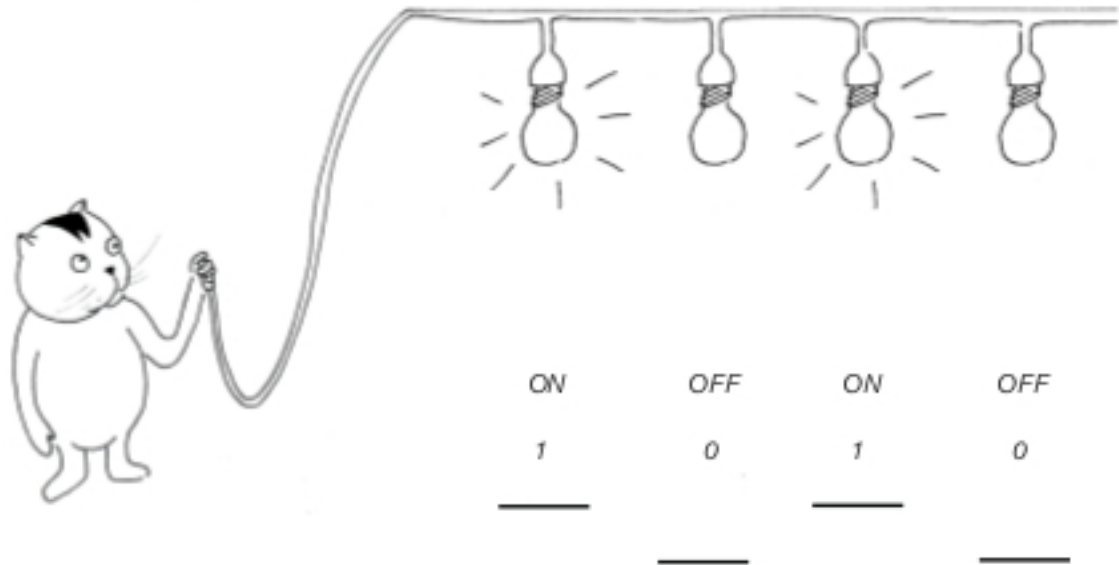

packet
as tag?

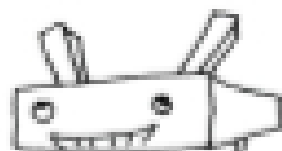

packet be?

...
nation address cannot...

That's how part of my
protocol would look like,
if it existed.

What happens when a
packet gets lost?

dirty
??

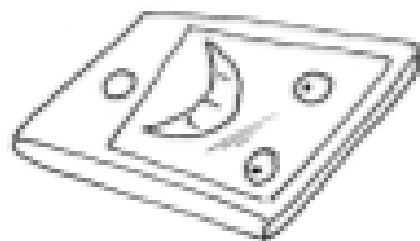

if hungry:
meow
if happy:
purr
if sleepy:
sleep

Protocols You've Heard

- “It me” by The IP
- “The internet’s address book” by DNS
- “Greatest hits” by The Notorious B.G.P.
- “If you like then you shoulda put an S on it” by HTTP

The IP

- The Internet Protocol
- Standardises:
 - How packets are structured
 - How internet addresses must be formatted
- An IP address is given to every device when it connects to a network
- Example (IPv4): 192.168.0.1
- Example (IPv6): 2001:0DB8:0000:0001::0010:01FF
- Secure version: IPSec

DNS

- Domain Name System
- Public, decentralized database that links a unique name to an IP address
- Standardises:
 - Hierarchical format of a name
 - How to hierarchically look up of an IP address
- Example: en.wikipedia.org
- Secure version: DNSSEC, others

The Notorious B.G.P

- Border Gateway Protocol
- The atlas of the internet
- Standardises:
 - Peering, or information sharing about packets
 - Transit, or calculations about shortest and cheapest routes for packets
- Example: Internet Exchange Points are physical expressions of how peered ISPs reduce costs and routing times.

HTTP

- Hypertext Transfer Protocol
- Giving you the World Wide Web since 1990.
- Standardises:
 - Headers: metadata about a webpage
 - Body: Structured text and links, including images
- Secure version: HTTPS

Discussion: Censorship

- Describe a time when you've not been able to use the internet or access content on the internet.
- From your example, take a guess at how the censorship was performed, technically.
- Share out one example per group.

Social Layer



Citizens



companies



non-profit organizations

Content Layer

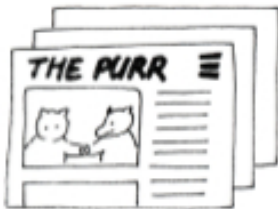

Websites (news sites, blogs)



social media



entertainment

Application Layer



Web-based platforms



email



instant messaging

Logical Layer

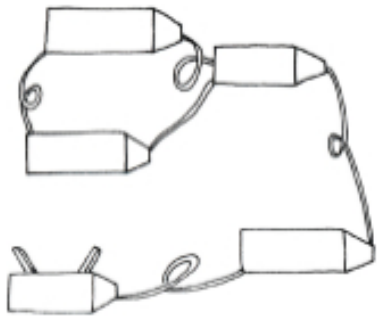

Networking



routing

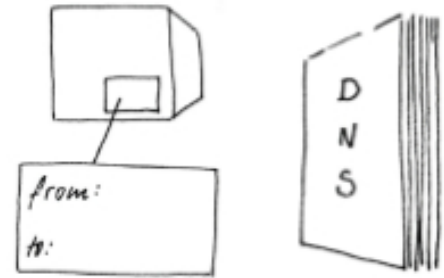

addressing (IP, DNS)

Infrastructural Layer



computers (servers, personal computers, mobile devices)

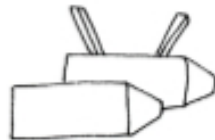

routers (gateways, switches)

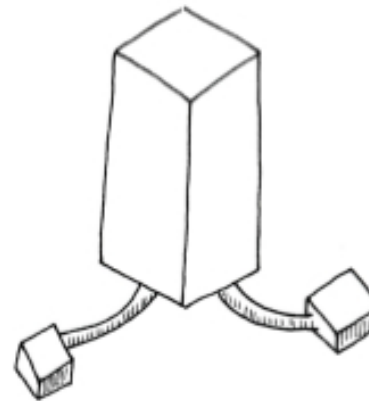

data centers



telecommunication cless networks, satelli

7. Application Layer

6. Presentation Layer

5. Session Layer

These are the layers at which we exchange data.

4. Transport Layer

Assures the reliable transmission of packets, grouped in so-called messages, segments (TCP) or datagrams (UDP).

3. Network Layer

This layer defines an addressing scheme, and how packets are routed over the network.

2. Data Link Layer

This layer defines the transmission of data frames between two directly connected nodes by a physical layer.

1. Physical Layer

The physical layer defines electrical and physical specifications of the data connection. At this layer, raw bit streams are sent and received over a physical medium (electrical cable, optical glass fiber, radio frequency spectrum.) Network adapters, repeaters, modems operate only at this low level.

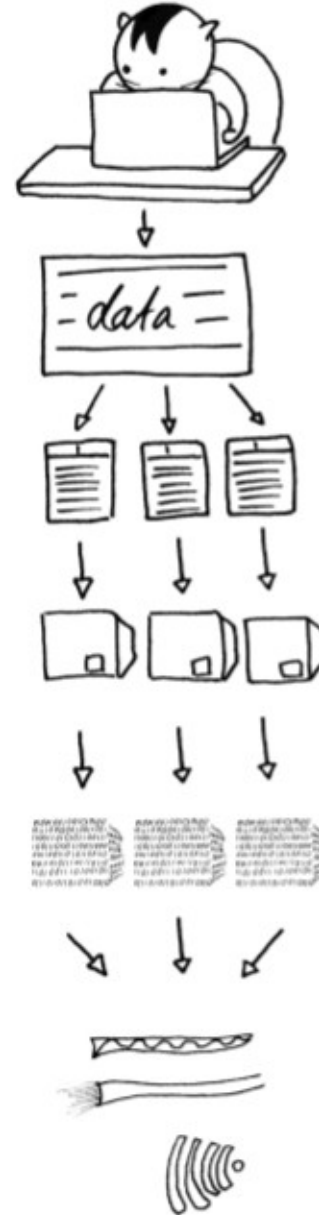

Infrastructure Layer

- The infrastructural layer is the physical technology through which packets travel. The physical Internet is comprised of:
 - Terrestrial cables
 - Undersea cables
 - Satellites
 - Wireless systems (3G, 4G, 5G, cellular towers) and
 - Data centers & Internet Exchange Points (IXP).
- This infrastructure is mainly privately owned by telecommunication companies all over the world.
- Standards bodies:
 - International Telecommunication Union

Logical Layer

- The logical layer is a set of procedures that create the rules that ensure that all the processes necessary to make the internet function.
- Standards bodies:
 - Internet Protocols & Standards for example TCP/IP, are developed and defined at the IETF.
 - Internet Services like the Domain Name System and the management of the Root Zones are managed by ICANN
 - Hardware and Wi-Fi standards are developed by the Institute of Electrical and Electronics Engineers (IEEE)
 - IP Addresses are globally assigned and distributed by IANA, RIRs
 - Standards There are many more organizations that develop standards, such as the International Organization for Standardization (ISO).

Content, Social and Economic

- The content layer can be seen as the heart of the political and public debate on Internet governance:
 - Privacy
 - Encryption
 - Freedom of speech and access to information
 - Intellectual property
- The Internet Governance Forum (IGF) was created to serve as a global forum for governments, private companies and civil society to discuss these issues.
- Social and Economic Layer:
 - States and governments
 - Private bodies and businesses
 - Policy organizations operating at the logical layer (IETF etc.)
 - Citizens.